









SOLDAR / APARAFUSAR PT



WWW.PERFIVIANA.PT

Referência	Perfis	Descrição
PT3016		Móvel portão de soldar 80mm c/ guia de correr integrada
PT3017		Móvel portão de soldar 80mm
PT3018		Travessa portão de soldar 80mm
PT3019		Móvel portão de soldar 42,5mm
PT3020		Fixo portão
PT3021		tampa para móvel portão de soldar
PT3022		bite para portão de soldar
PT4040		Móvel portão de soldar 100mm
PT4041		inversor para portão

Soldar

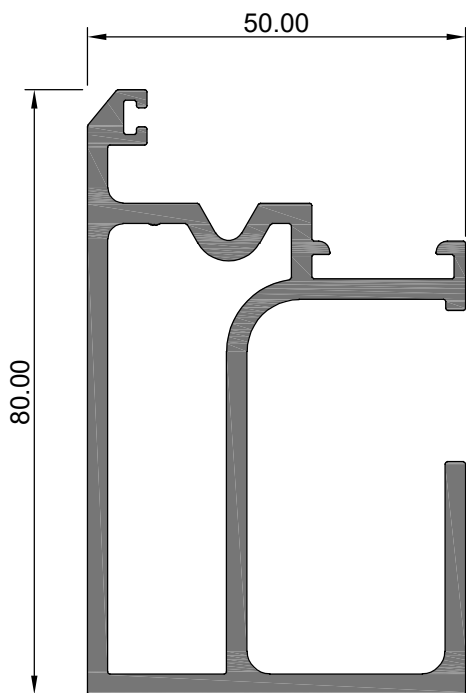

PT3016

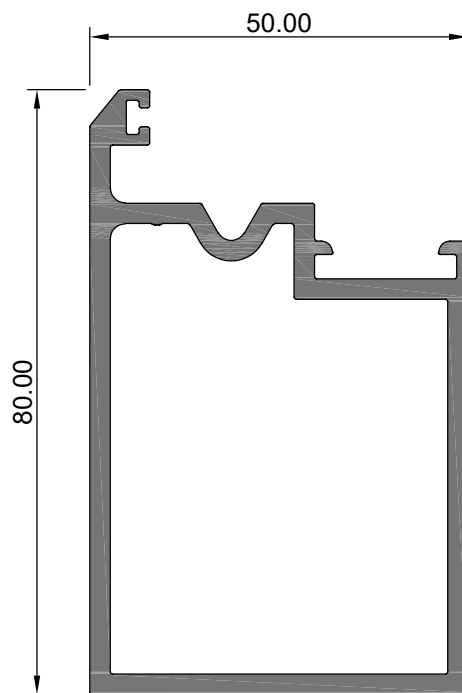

PT3017

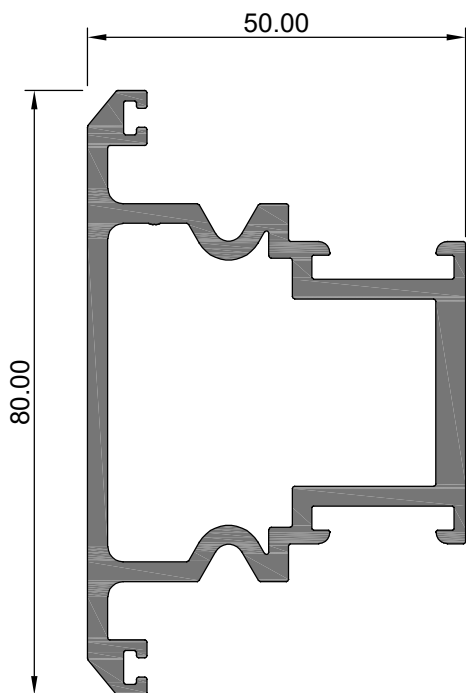

PT3018

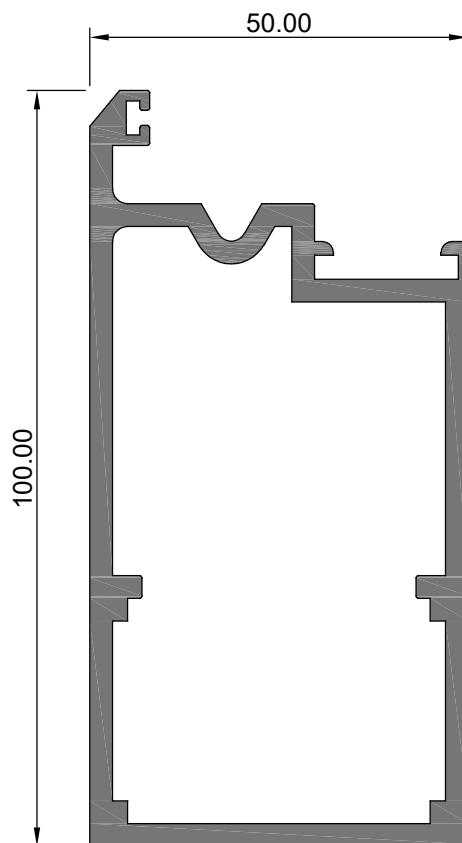

PT4040

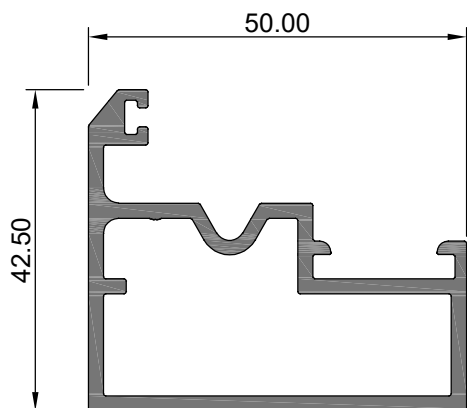

PT3019

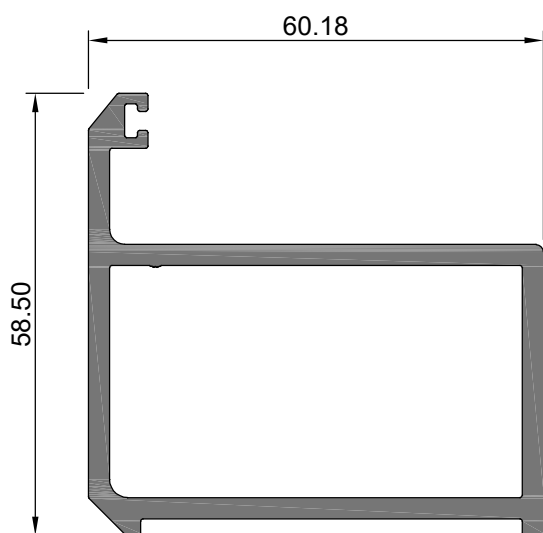

PT3020

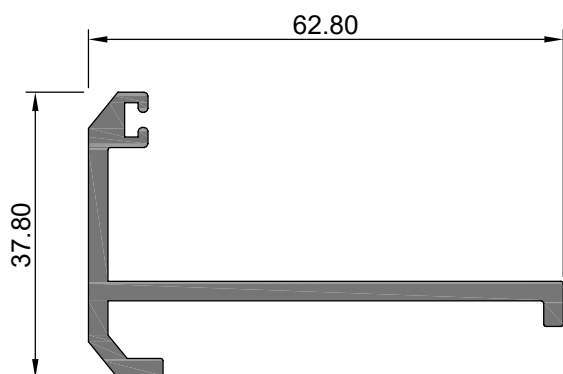

PT4041

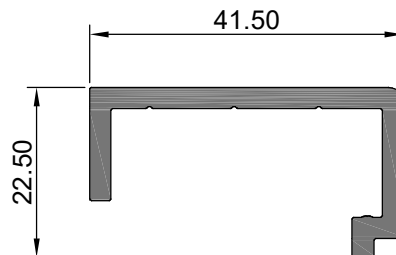

PT3021

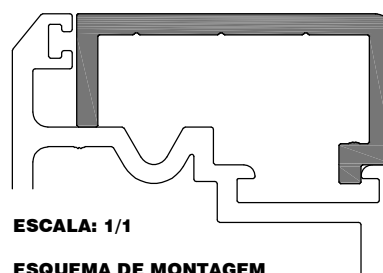

ESCALA: 1/1

ESQUEMA DE MONTAGEM

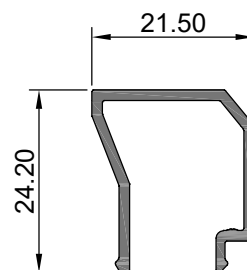

PT3022

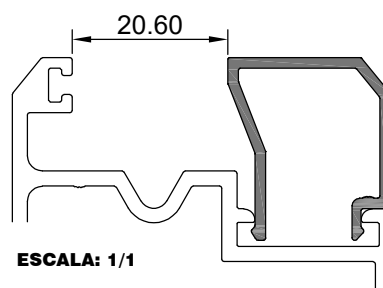

ESCALA: 1/1

TRABALHA COM PERFIS:
ADL 3016, ADL 3017, ADL 3018,
ADL 3019, ADL 4040

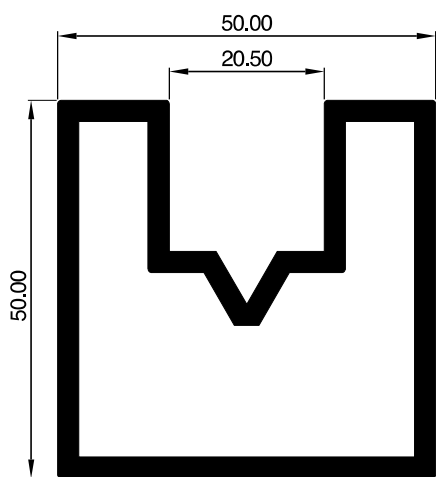

PT1006

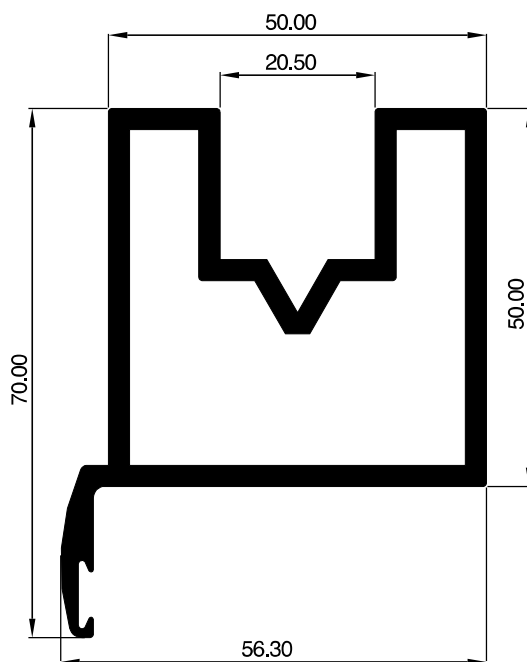

PT1007

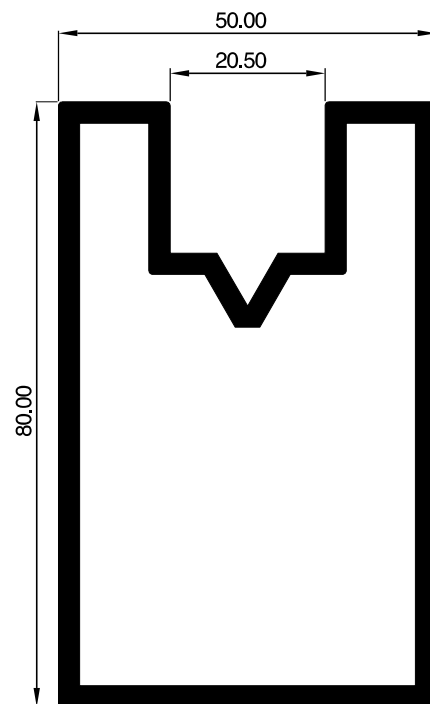

PT1008

156

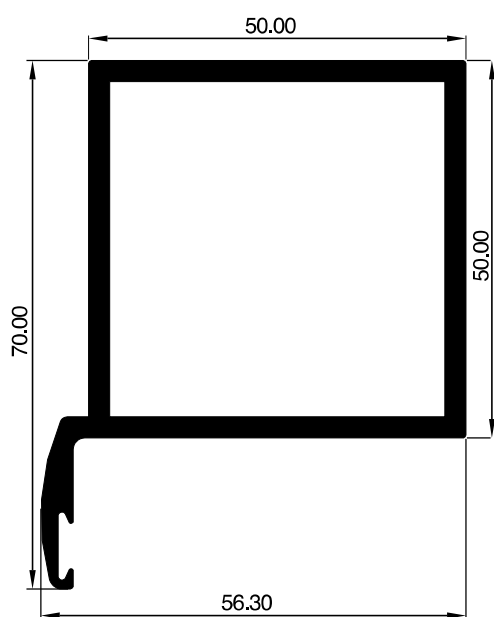

PT1010

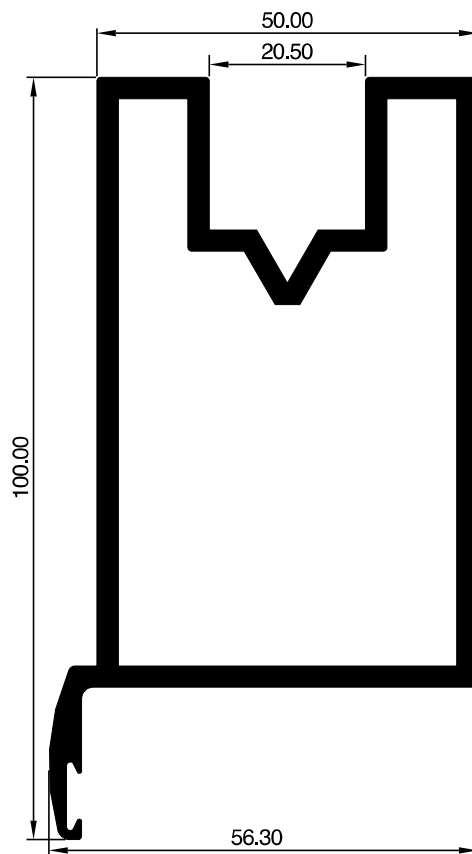

PT1009

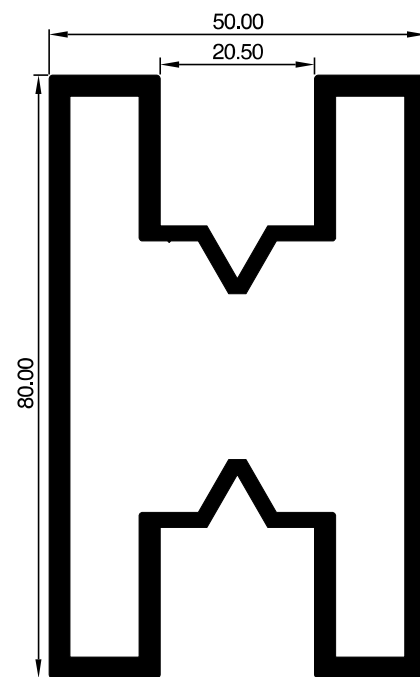

PT2563

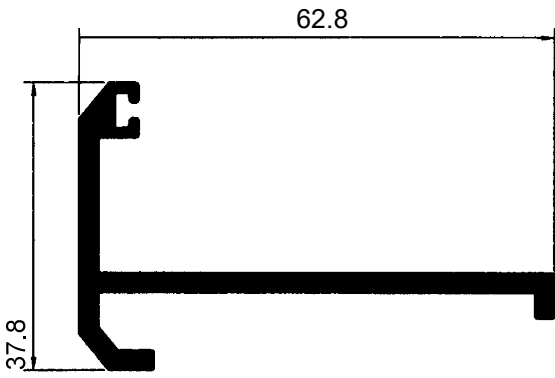

PT4041

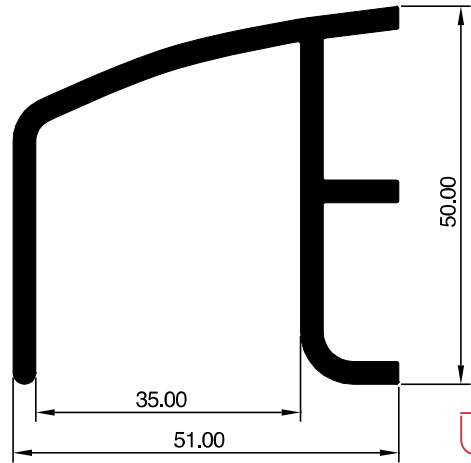

PT1014

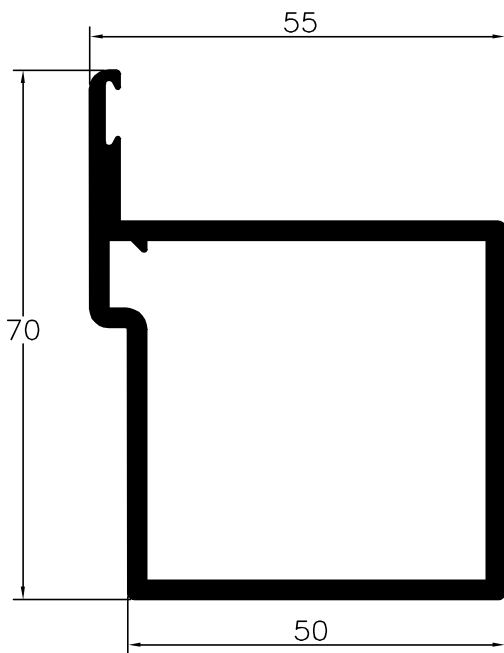

PT1917

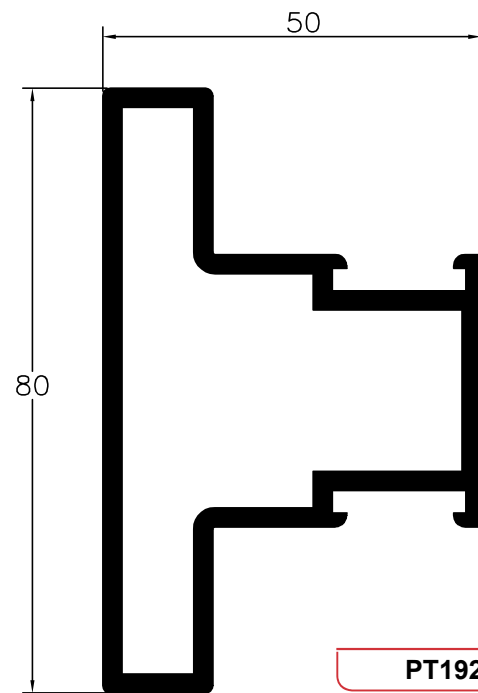

PT1920

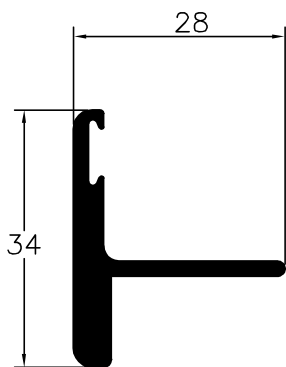

PT1918

PT1919

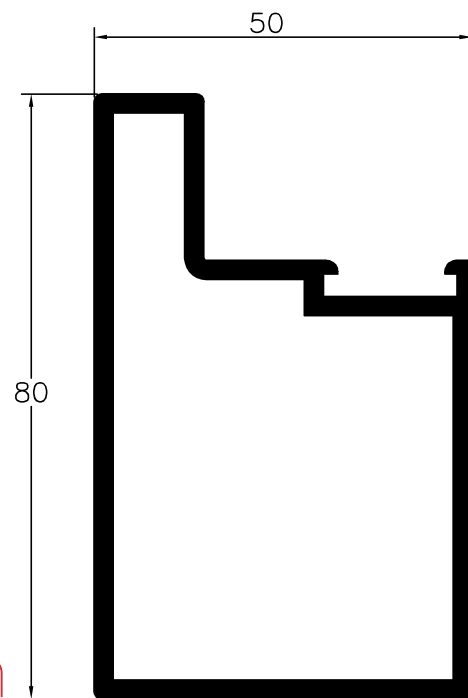

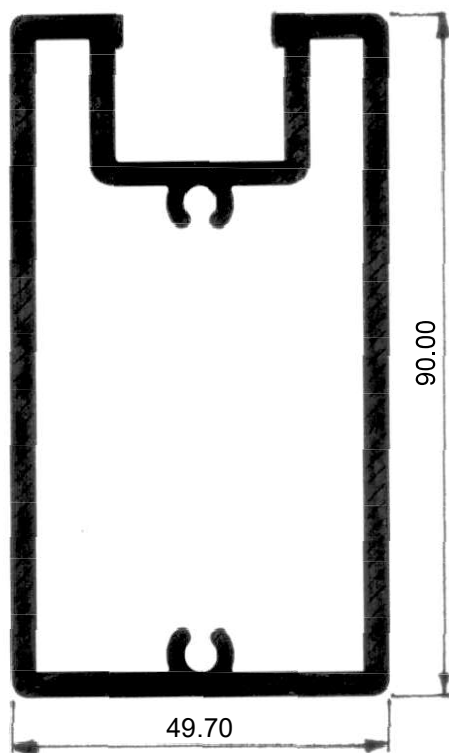

PT04

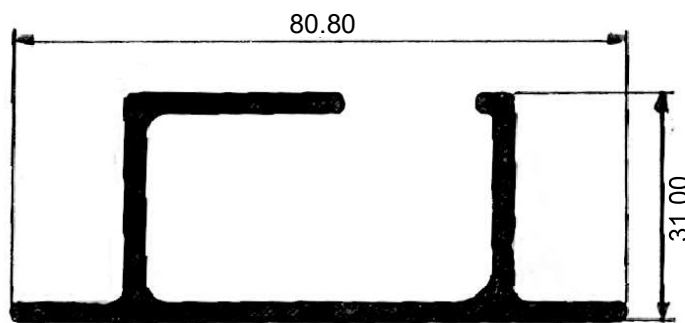

PT11

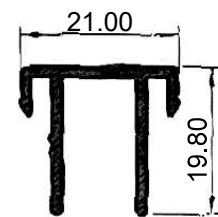

PT09

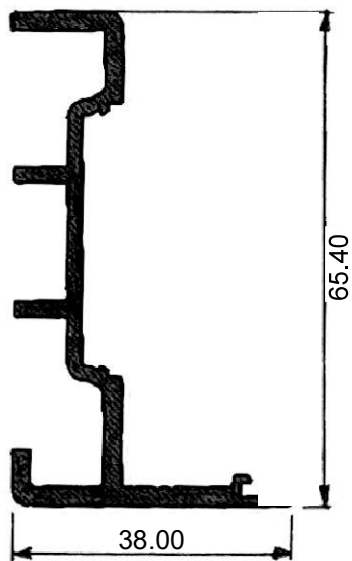

PT08

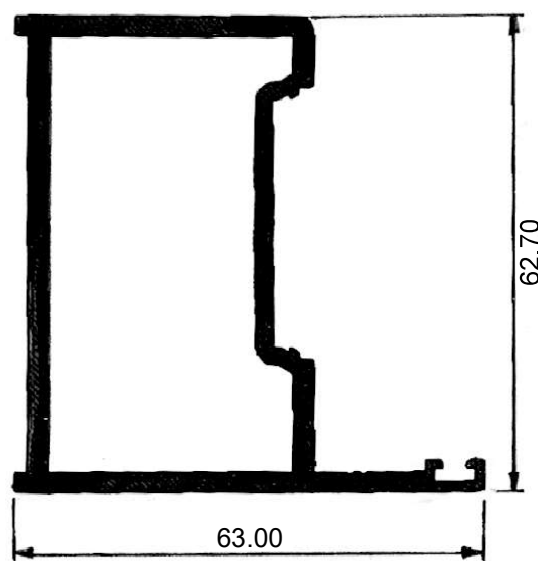

PT05

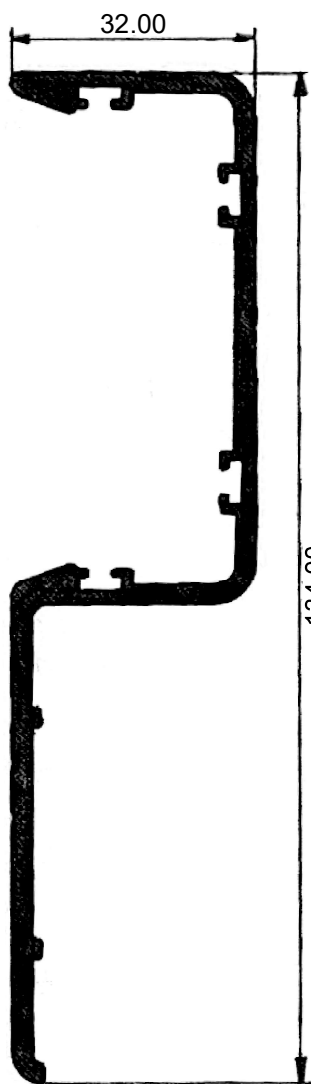

PT10

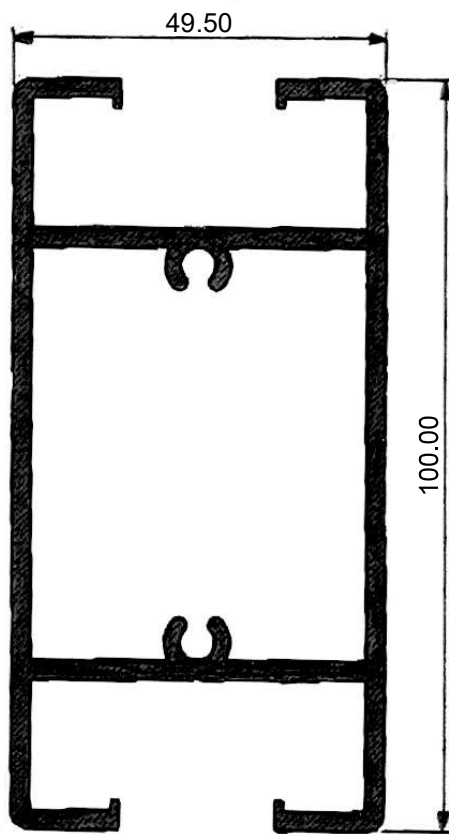

PT07

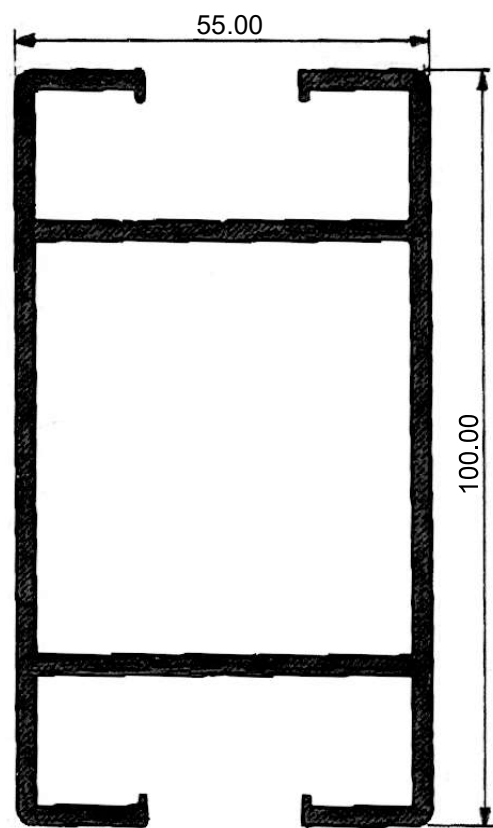

PT06